

FOOD SAFETY FACT SHEET

FOOD SAFETY TIPS FOR OUTDOOR EVENTS

TEMPERATURE CONTROL

Low temperatures prevent food poisoning bacteria, which may be present in food, from multiplying to dangerous levels.

High temperatures will kill most bacteria and viruses.

Because bacteria can grow to unsafe levels between 5°C and 60°C, we call it the "Temperature Danger Zone".

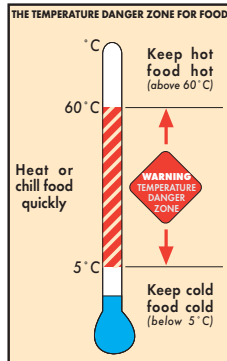

- Potentially hazardous foods (foods like cooked meat and foods containing meat, dairy products, prepared fruits and vegetables, cooked rice and pasta, and cooked or processed foods containing eggs) should be kept under temperature control, including during the time it is being transported – this means that hot food should be kept at 60°C or above, cold food should be at 5°C or below and frozen food stays frozen. Use a probe type thermometer to regularly measure the temperature of foods.
- When refrigeration is not available the easiest way to keep risky foods cool when transporting or storing them is to use portable car fridges, insulated cool/hot boxes or eskies with plenty of ice.
- Nonetheless, you can transport or keep potentially hazardous food out of temperature control for short periods of time by applying the 2 hour / 4 hour guide. This guide means that you can have freshly prepared food out of temperature control for up to 2 hours then refrigerate it for later use. If out of temperature control for between 2 hours and 4 hours use the food. After 4 hours throw it out.

COOKING and REHEATING

Cooking is an effective way to kill dangerous germs in food, but the food must be cooked or reheated to a temperature high enough to destroy most bacteria and viruses.

- If you are cooking or reheating food at your outdoor event make sure you cook/heat it properly (to at least 75°C) and keep hot food steaming hot (above 60°C).
- Preheat food before placing in a hot holding device eg. bain marie.
- Particular care should be taken with rolled or stuffed meats, mince, sausages, patties, kebabs and whole poultry, all of which should be cooked thoroughly right through to the centre (until the juices run clear) as bacteria are distributed throughout these foods. Steaks, chops and whole roasts however can be cooked to preference.

CROSS CONTAMINATION

Avoid cross-contamination, make sure that microbes don't have a chance to hitchhike from raw materials onto cooked food, or from your body, or a pet, to cooked or ready to eat food.

- Thoroughly wash and dry hands regularly, especially before preparing food, after handling raw meat and after going to the toilet.
- Minimise hand contact with ready to eat foods where practical by using utensils to handle the food or by using disposable gloves. If using disposable gloves change them as often as you would otherwise wash your hands.
- Clean and sanitise utensils such as tongs, knives and chopping boards in between handling raw and cooked foods or use separate chopping boards, containers and utensils for cooked and raw foods. It is a good idea to provide single serve, disposable eating utensils to customers to minimise the need to wash-up.
- All food contact surfaces must be regularly cleaned and if they come into contact with ready-to-eat food, sanitised.
- Always use a clean plate and tongs for cooked meat – never the same plate that held the raw meat. Keep raw meat well away from foods which are ready to eat, such as cooked meat and salads and never use raw meat marinade to baste meat near the end of the cooking cycle.
- All practicable measures need to be taken to protect any food displayed or stored from the likelihood of contamination – cover open or exposed food or store it in appropriate containers with tight fitting lids.
- Regardless of how food is transported, protect it from contamination during the journey as well as when it is stored. All foods should be protected from insects, vermin, dust and animals by keeping it wrapped or in sealed containers, and raw products must be separated from cooked and ready to eat foods.
- Clean outer clothing must be worn when handling food and cuts or abrasions are best covered with brightly coloured band-aids and a water proof covering (eg. disposable gloves).

- Staff or volunteers suffering from, or having symptoms of a food-borne illness (especially diarrhoea or vomiting) have a duty to report their illness to the organisers and must not handle food which is to be consumed by others.



FOOD SAFETY TIPS FOR OUTDOOR EVENTS

LET YOUR COUNCIL KNOW

All temporary catering outlets are required to have notified the Council where their business is based (or the Environmental Health Service if not within a local government area) of their operations, and comply with the requirements of the Food Act and the Food Safety Standards.

Planning and By Law provisions may restrict or impose certain conditions for operators of temporary catering outlets and mobile vans in some Council districts – check what applies in the Council areas that you operate within.

FOOD HANDLER'S SKILLS and KNOWLEDGE

Food handlers, including volunteers, are required to have appropriate food safety skills and knowledge for the jobs that they do. Fundraising events are exempt from this requirement only if the food is not potentially hazardous (eg. selling only cakes, biscuits and confectionery), or the potentially hazardous food is likely to be consumed immediately after cooking (eg. sausages, hamburgers & hot dogs).

TEMPORARY FACILITIES

(eg. tents, sheds, marquees, street stalls and open air stalls)

Set up your stall to ensure your space and layout is of sufficient size for your operations and that work flows are organised to minimise cross contamination.

The Environmental Health Officer from your local Council can provide advice regarding appropriate physical facilities which may include the need to have walls, floors and ceilings depending on the extent, location and the nature of the food handling activities proposed.

WATER SUPPLY and HAND WASHING FACILITIES

Sufficient quantities of potable (drinking) water must be available for activities such as hand washing, food preparation and cleaning utensils.

Where temporary food premises that sell unpackaged food don't have access to a suitable water supply, tanks or other suitable containers (with a tap valve) for clean water storage will need to be provided unless a written exemption is obtained from the local Council.

An easy way to provide hand washing facilities at temporary locations is shown opposite.

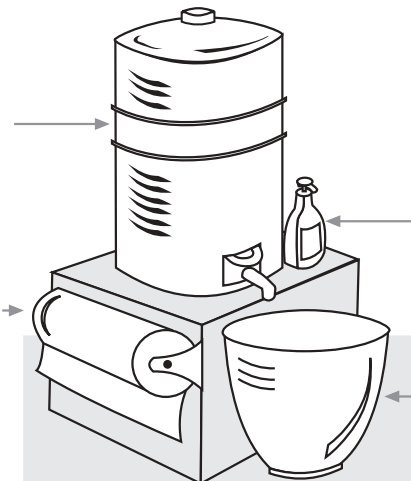

Organisers of large events may find "Guidelines for the Management of Public Health and Safety at Public Events" located at the same web address (click on "Publications") helpful for planning and organising their events

WASTE DISPOSAL

Make sure you have adequate vermin proof receptacles for solid waste, recyclables and liquid waste.

Solid waste should be bagged and tied, kept well away from food preparation areas and be collected and disposed of as required.

Council's Environmental Health Officer can advise the best means to contain and dispose of waste water where sewer is not readily available.

PROVISION OF STAFF and PUBLIC TOILETS

Ensure adequate toilet facilities are provided for the number of expected attendees and staff.

Arrange regular cleaning and maintenance of the facilities and their surrounds if needed.

Ensure toilets contain hand washing facilities which include soap, running water and hand drying facilities.

DUST CONTROL

In exposed areas implement dust reduction measures to reduce food contamination (eg. ground cover/mats, water spray trucks etc.).

FIRE PROTECTION

It is a good practice to have an appropriate type fire extinguisher located near outlets where cooking and/or heating processes are used.

COUNCIL INSPECTION

Council's Environmental Health Officer may inspect the outlet at any time whilst it is in operation.

FOOD LABELLING at FUNDRAISERS

Food sold at a fundraising event is exempt from labelling requirements. Some fundraiser organisers nonetheless prefer to see labels on packaged food that they sell to provide basic information to the purchaser and especially to anyone who needs to avoid certain ingredients such as nuts, eggs, wheat or seafood. A basic label could include:

- The name of the fundraising event
- A description of the food, for example 'strawberry jam' or 'chocolate cake'
- A list of the ingredients
- A code to indicate who made the food
- A 'best before' date to indicate how long the food will keep
- Any special storage conditions

NEED MORE INFORMATION OR ASSISTANCE?

Your first point of contact is the Environmental Health Officer at your local Council.

Alternatively you may call the Environmental Health Service on 08 8226 7100.

Information and resources are available at www.dhs.sa.gov.au/pehs (click on "Food").

ARTISTS IMPRESSION – MINIMUM STANDARDS FOR THE OPERATION OF A TEMPORARY FOOD STALL

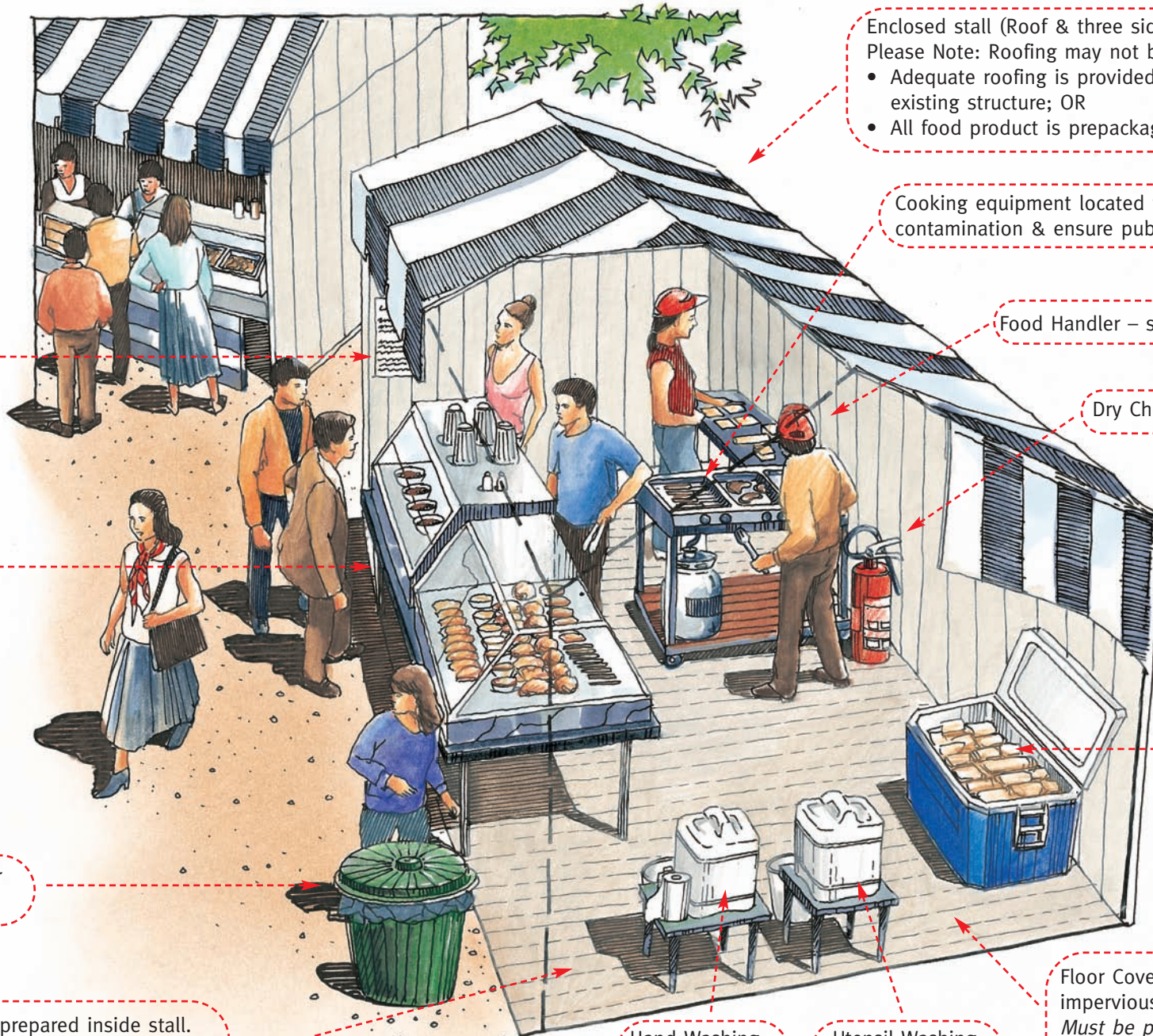

Ensure a minimum distance of 10 metres separates food operations and any areas that are accessed by animals

Display of current Certificate of Food Licence for Temporary Food Stall (if applicable)

Food display, Food protection, Taste Testing - see over

Refuse Bin with lid and liner supplied

All food prepared inside stall. No food stored directly on ground. Overall clean condition.

Enclosed stall (Roof & three sides)

Please Note: Roofing may not be required where:

- Adequate roofing is provided when located within an existing structure; OR
- All food product is prepackaged (no taste testing)

Cooking equipment located to protect food from contamination & ensure public safety

Food Handler – see over

Dry Chemical Fire Extinguisher

Temperature Control for potentially hazardous and perishable foods - see over

Hand Washing Facility - see over

Utensil Washing Facility - see over

Floor Covering – easy to clean, impervious material. **Please Note:** Must be provided if located on unsealed ground.

Minimum hand washing facilities

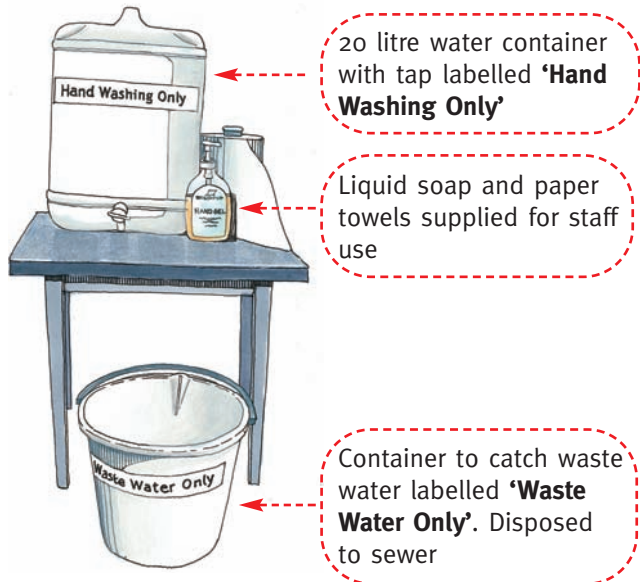

20 litre water container with tap labelled '**Hand Washing Only**'

Liquid soap and paper towels supplied for staff use

Container to catch waste water labelled '**Waste Water Only**'. Disposed to sewer

Minimum utensil washing facilities

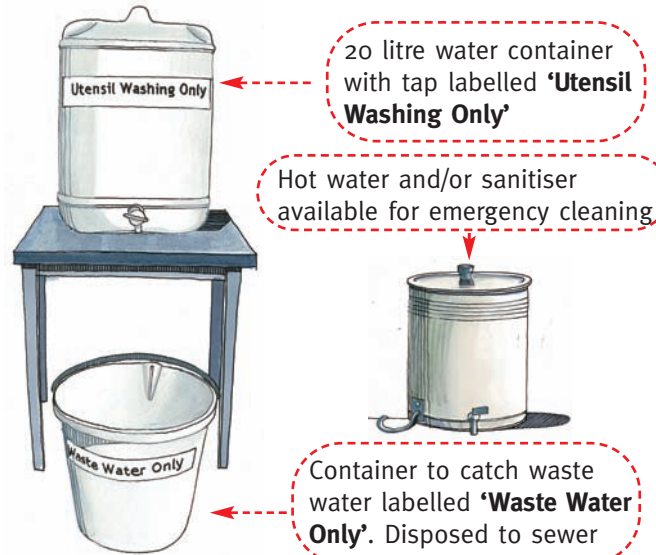

20 litre water container with tap labelled '**Utensil Washing Only**'

Hot water and/or sanitiser available for emergency cleaning

Container to catch waste water labelled '**Waste Water Only**'. Disposed to sewer

Two containers of sufficient capacity are to also be provided for adequate cleaning of utensils

Food Handlers



Money and food handled separately

Utensils and gloves used to handle food

Clean person, attire and habits

Hands must be washed whenever hands are likely to contaminate food

No smoking within temporary food stall

No cuts, illness, sores on food handlers

Food display, food protection, taste testing

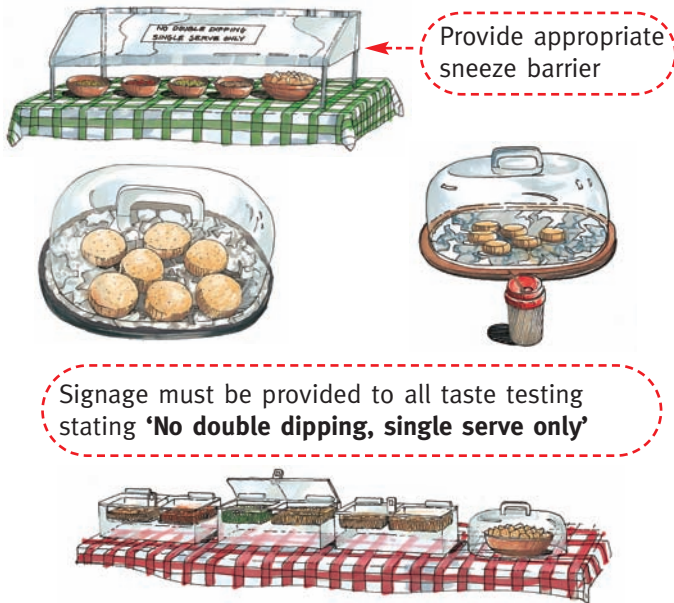

Provide appropriate sneeze barrier

Signage must be provided to all taste testing stating '**No double dipping, single serve only**'

Sauces, condiments and single serve utensils

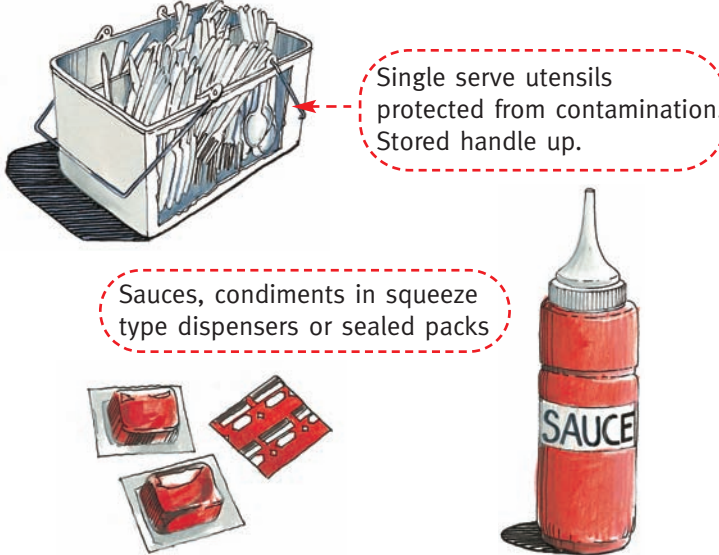

Single serve utensils protected from contamination. Stored handle up.

Sauces, condiments in squeeze type dispensers or sealed packs

For further information on this topic, please contact Council

Temperature control of potentially hazardous food

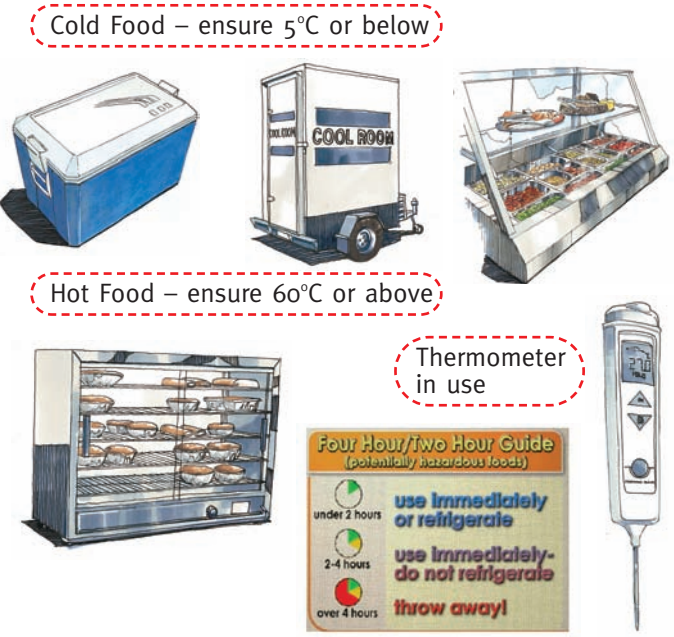

Cold Food – ensure 5°C or below

Hot Food – ensure 60°C or above

Thermometer in use

Four Hour/Two Hour Guide (potentially hazardous foods)	
under 2 hours	use immediately or refrigerate
2-4 hours	use immediately - do not refrigerate
over 4 hours	throw away!